

Buy Here Pay Here (BHPH)

Lee Fitts AutoZone

Kris DeWolfe ALLDATA

1-19-2015



BHPH

Agenda

- Intro
- Recon
 - Ordering
- Stocking & Shelving
- New -vs- Aftermarket
- ALLDATA



Introductions:



AutoZone:

Lee Fitts/ Business Development National Account Mgr.

ALLDATA:

Kris DeWolfe/ National Account Manager



BHPH Industry



AutoZone / ALLDATA has been researching the Buy Here Pay Here industry for several years. We want to provide some results of the studies done across US on Recon costs. We understand that if you have a service department, it is there primarily to support your investment!

[Consumer Reports](#) estimates that 35%, or as many as 79 million people in the United States had subprime or below credit in 2010.

BHPH -Recon



- Recon check list - Follows your warranty
- Provide a warranty or services for your customers
- Purchase Order (PO)
- Have your parts supplier bundle all parts by job
 - Put all jobs in totes with (PO) on front
- Verify all orders upon delivery

BHPH –Ordering



- Order parts online for Efficiency
- Purchase Order (Link to repair)
- Try to use a Primary Supplier
 - Delivery Time
 - Pricing
 - Warranty
 - Returns
 - Cores
 - Billing

BHPH –Stocking



- Stocking
 - Limit backroom stock to fast moving items (Filters, Wiper Blades, Light Bulbs, etc.)
- Shelving
 - Limit Special Orders to Less Than 30 Days on Hand
 - Inventory EVERY 30 days and return unused parts

BHPH New –vs- Aftermarket



- Review new cost saving ideas for your 10 most popular vehicles
- Demonstrate ways to find this type of information for future requests
- Demonstrate the importance of sharing information

How do we efficiently and effectively find Dorman's cost saving repairs for AutoZone?

BHPH - DORMAN

DIRECT FIT
REPLACEMENTS

Reduce Repair Cost 
Replace just the failed part, not the entire Hub Assembly



BHPH

- ***PT Cruiser***
 - ***905-201 Rear watts link / Bell Crank***
 - ***3 skus available***

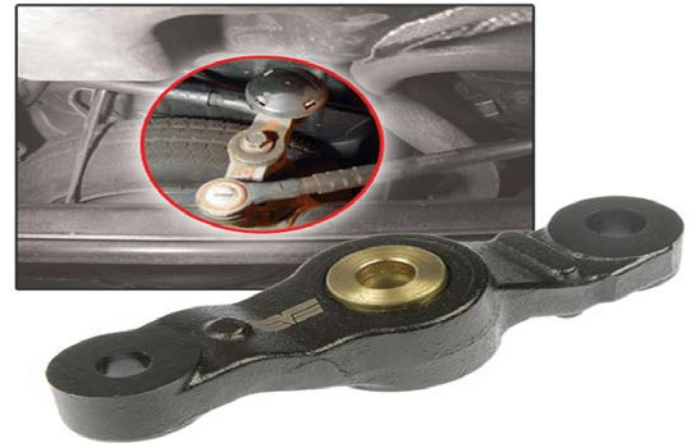

BHPH

- ***PT Cruiser***
 - ***599-909 Totally Integrated Power Module***
 - ***7 Skus Available - Dodge, Chrysler and Jeep***



BHPH

- ***Ford Taurus***
 - ***586-005 – Factory Radio Replacement***
 - ***AUX jack, 4 skus available***



BHPH

- ***Ford Taurus***
 - ***924-250 Windshield Washer Hose***
 - ***Cracks and dries out - 2 skus GM and Ford***



BHPH

- ***Chevy Cobalt***
 - ***924-712 Shift Park Release link***
 - ***Also fits HHR, 25 Shift release repairs***

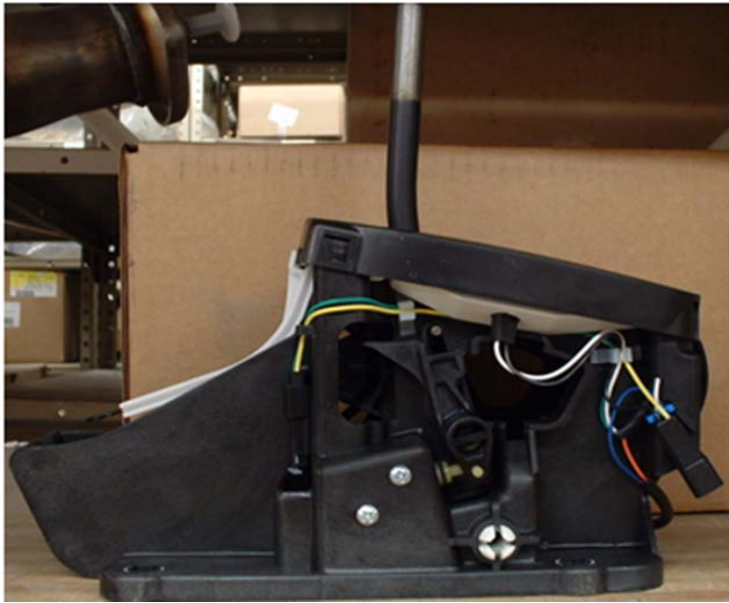

BHPH

- ***Chevy Cobalt***
 - ***917-270 – Camshaft Phaser***
 - ***917-216 – VVT, Over 50 skus available total***

ENGINE VARIABLE TIMING SOLENOID



ENGINE VARIABLE TIMING SPROCKET



BHPH

- ***Chevy Impala***
 - ***425-158– Steering Shaft***
 - ***Redesigned, over 40 skus***

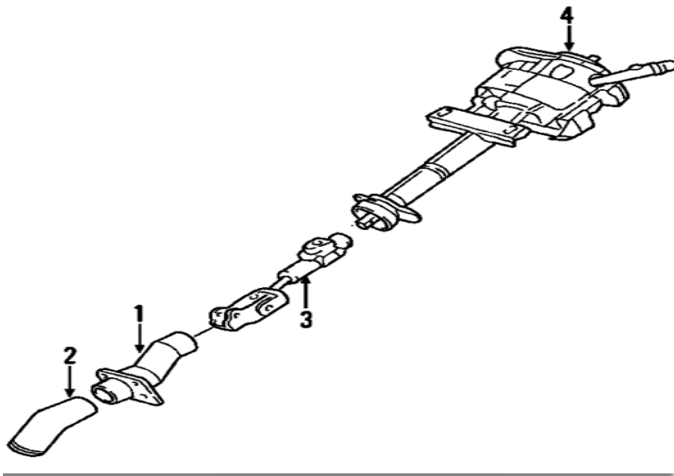

BHPH

- **Dodge Caravan**
 - **924-513 Spare Tire Hoist Redesigned**
 - **12 skus**



SPARE TIRE HOIST



BHPH

- **Dodge Caravan**
 - **924-911 – Sliding Door Roller**
 - **14 Skus including Honda Odyssey**

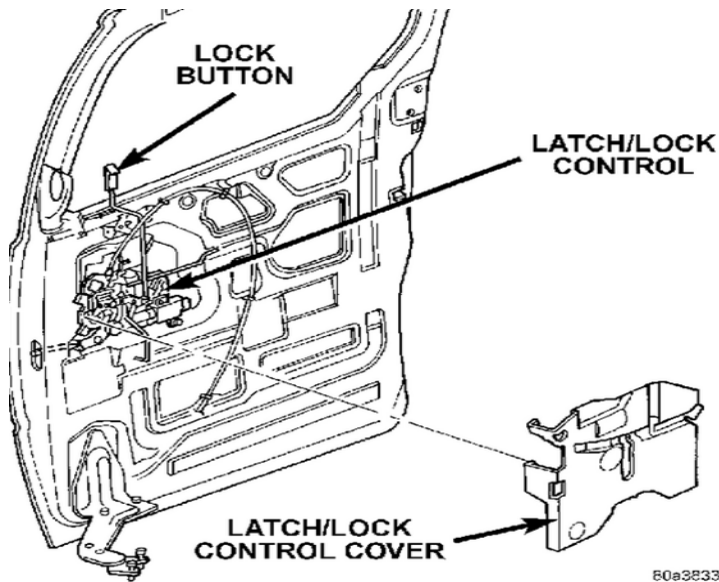

BHPH

- ***Chevy Malibu***
 - ***13731– Key Fob 5 button with programmer***
 - ***13624 – Key fob Case, over 100 skus available***

KEY FOB



KEYLESS REMOTE CASE



BHPH

- ***Chevy Malibu***
 - ***927-111 – Sway Bar kit***
 - ***Re-engineered, Complete kit. Over 90 skus***



BHPH

- ***Chevy Trailblazer***
 - ***600-115 4WD Axle Disconnect***
 - ***Re-engineered to address failure mode – synthetic grease***



BHPH

- ***Chevy HHR***
 - ***80369 – Interior Door Handle replacement***
 - ***Over 3,000 handles, over 200 unique repairs***



BHPH

- ***Chevy HHR***
 - ***917-003 – Oil Filter Cap, 17 skus***



AutoZone



- National Account Pricing
- Electronic Ordering - 2% Rebate
- Labor Claims Credited in 48 Hours
- Referral Program –Free Advertisement
- Grand Opening Support
- 100% Labor Guarantee

AutoZone



- **Dedicated Onsite Commercial Specialist**
 - Locations that exceed (\$40k/month)
 - Full Time Equivalent
 - Onsite during normal business hours
 - Manages parts sourcing, consignment, stocking programs, cores, deliveries, returns and provides support for your financial systems

AutoZone and ALLDATA E-services



- AutoZone and ALLDATA Software Products provide today's Automotive professional the tools to address several of their basic business needs:
 - Recon Vehicles
 - Track Service and Costs
 - Increase Technician Efficiency
 - Improve Collision Operations

ALLDATA REPAIR



ALLDATA COLLISION



ALLDATA MARKET



ALLDATA MANAGE



ALLDATA MANAGE ONLINE



ALLDATA TRAINING GARAGE



Recon Vehicles

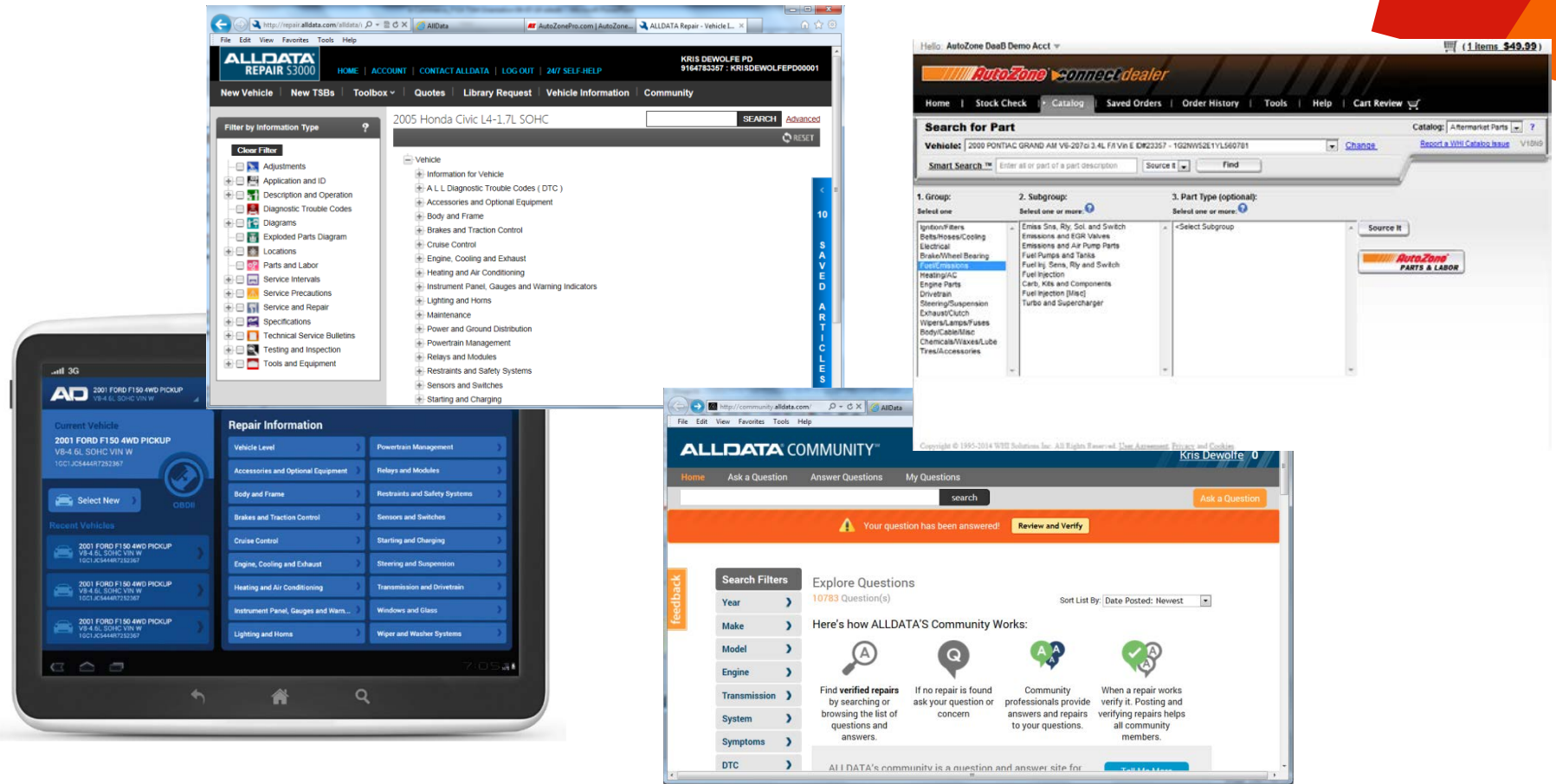

ALLDATA Mobile - ALLDATA Repair- ALLDATA Community

Go The Extra Mile | **GOTTChA** | **Trustworthy Advice** | **WOW!** Customer Service | **WITTDJR** | **Customers First!** | **Deliver When Promised** | **AZ6 Selling** | **Trusted Partner**

Recon Vehicles

ALLDATA Repair:

- Recondition Used Cars
 - Control Cost
 - Better Estimates
- Decrease Service Cost
 - OEM information for “ALL Makes”
- Identify recon costs up front
- Liability Pass through

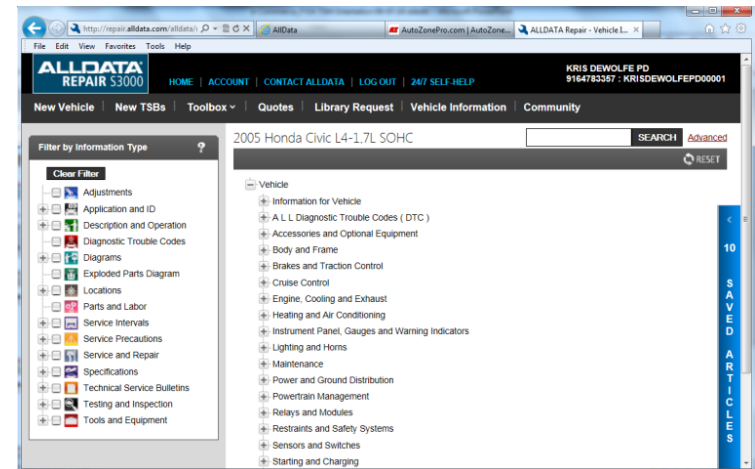

Recon Vehicles

ALLDATA Mobile

- Scan Trade Target vehicles for Engine Codes
 - Reduce recon cost
- Increase Service Revenue
 - OEM information for “ALL Makes”
- Improve Service Drive Efficiency
 - Move prelim diagnostics to service drive
- Improve Technician Efficiency
 - Move OEM data to the vehicle at the time of repair



Recon Vehicles

ALLDATA Community

- Reduce diagnostic time
 - Get answers on tough repairs
- Get Expert Advice
 - ASE techs with access to OEM repair information
- Technician Hotline Service
 - Free with subscription to ALLDATA Repair

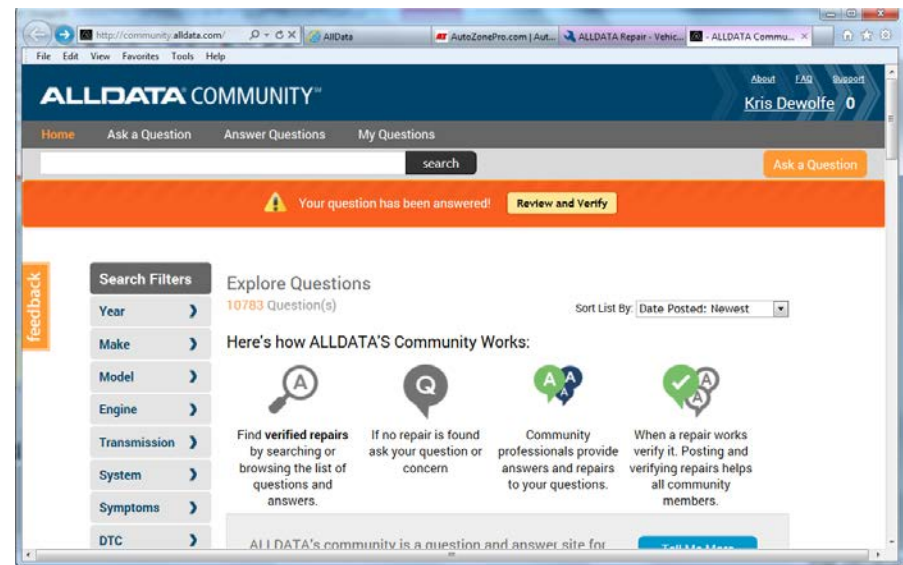

Recon Vehicles

AutoZone DealerConnect

- Identify part costs up front
 - Create estimates with real parts costing
- Track repair history
 - Save written estimates
- Identify labor costs
 - OEM Labor data for mechanical repairs

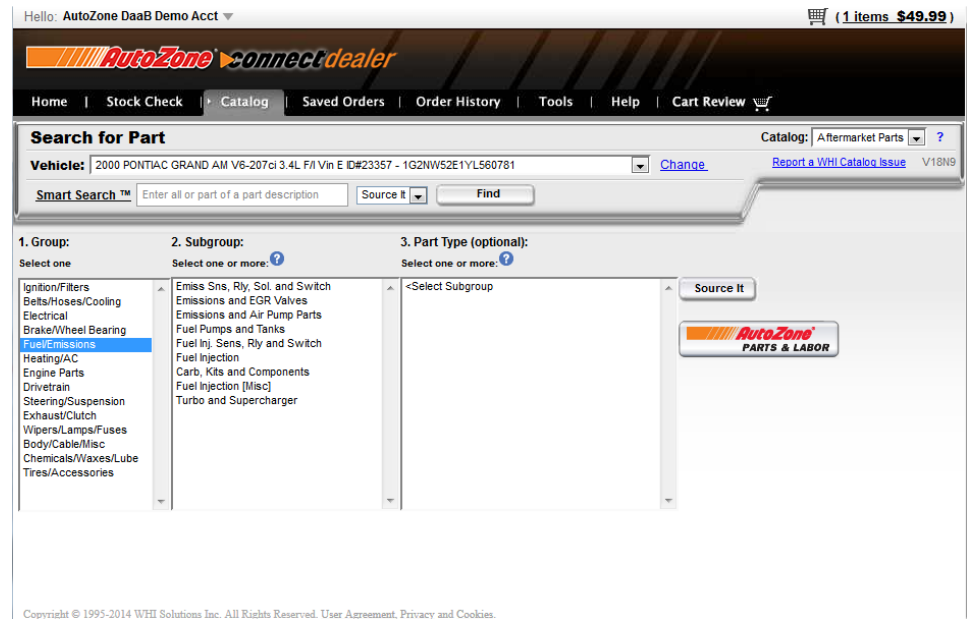

Track Service and Costs

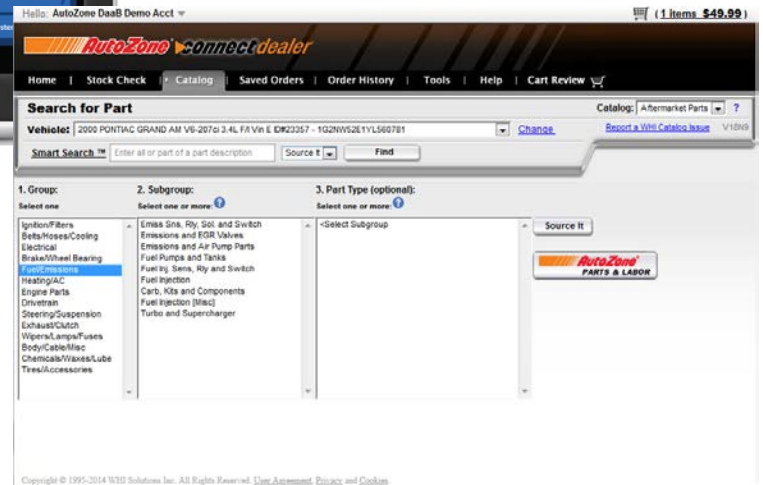
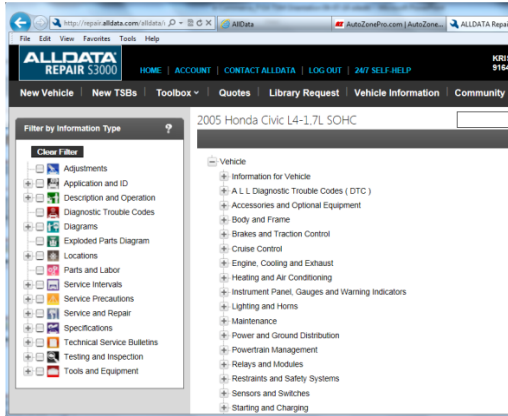

ALLDATA Repair ALLDATA Mobile AutoZone DealerConnect

Go The Extra Mile

GOTTChA

Trustworthy Advice

WOW! Customer Service

WITTDJR

Customers First!

Deliver When Promised

AZ6 Selling

Trusted Partner

Track Service and Costs

ALLDATA Repair

- Quote and Track repairs
- Identify TSBs and Recalls for ALL Makes
- Identify factory Maintenance for all Makes
- Timing Belt Intervals

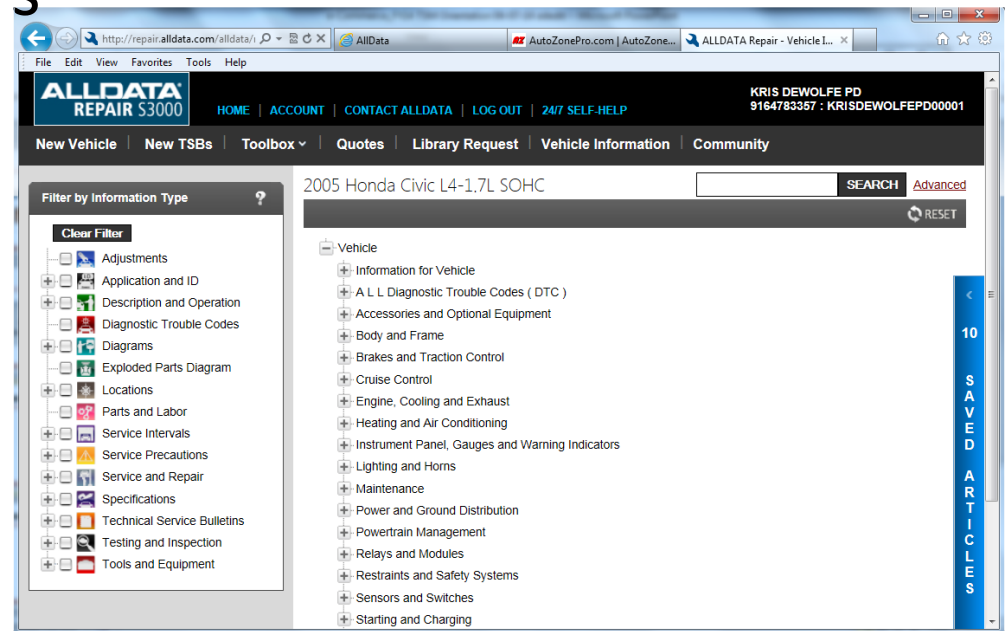

Track Service and Costs



AutoZone Dealer Connect

- Real Time Aftermarket Parts availability and ordering
- OEM Parts and Labor Data
- Specifications
- Technical Service Bulletins and Recalls

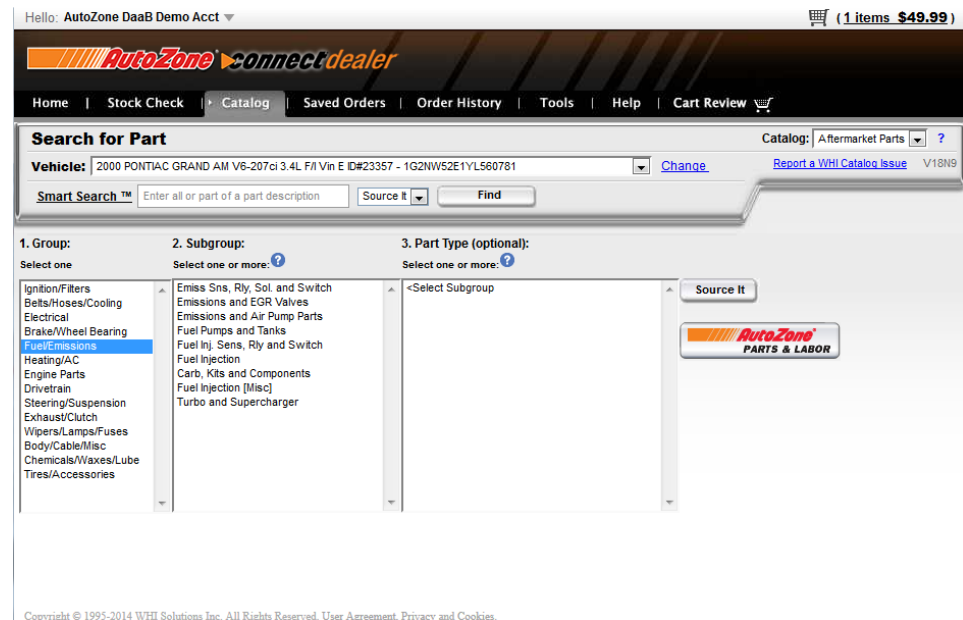

Track Service and Costs

ALLDATA Mobile

- Estimate repairs
- Diagnose engine codes for ALL Makes in the service drive or at auction



Increase Technician Efficiency

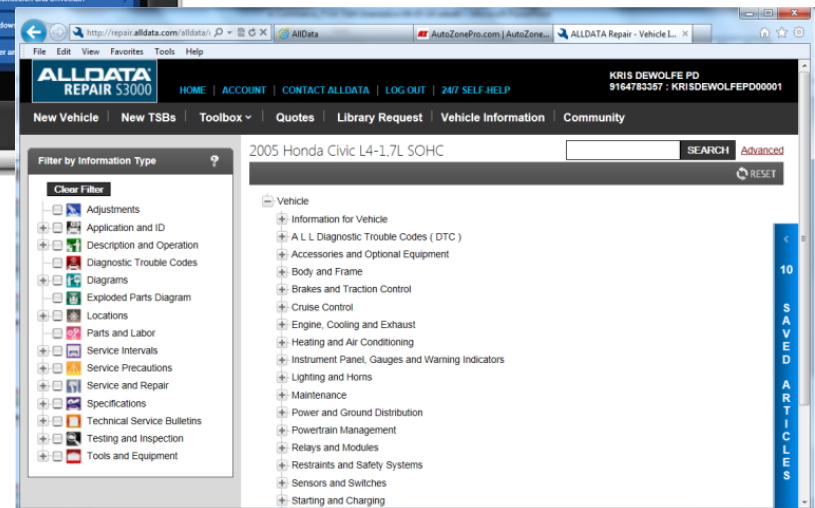
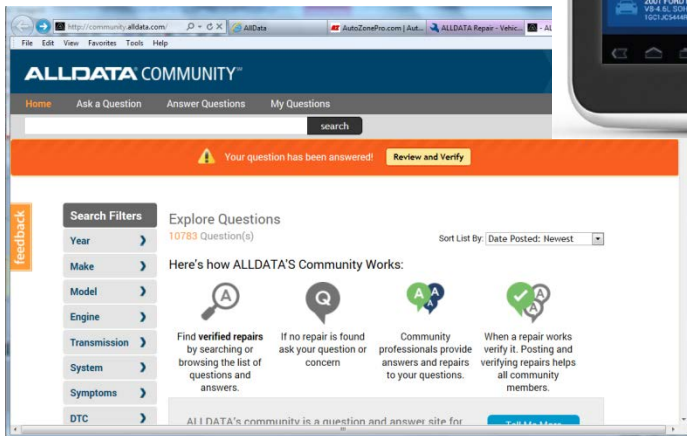

ALLDATA Community - ALLDATA Mobile - ALLDATA Repair

Increase Technician Efficiency

ALLDATA Community

- Fix Tough Repairs
 - Search community for answers
- Get Expert Advice
 - ASE techs with access to OEM repair information
- Technician Hotline Service
 - Free with subscription to ALLDATA Repair

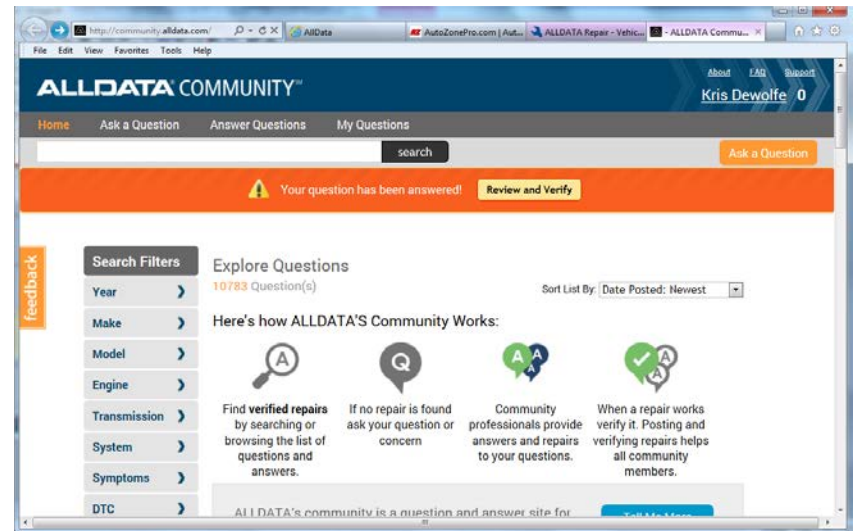

ALLDATA Community - ALLDATA Mobile - ALLDATA Training Garage

Increase Technician Efficiency

ALLDATA Mobile

- Improve Technicians access to data
 - Provides access to information at the vehicle
- Increase diagnostic Capability
 - Use the mobile device for code pulls and resets and to determine severity of repairs needed



ALLDATA Community - ALLDATA Mobile - ALLDATA Training Garage

Increase Technician Efficiency

ALLDATA Repair

- Improve capability to service all makes
 - OEM data for all makes
- Reduce/Control Reconditioning Costs
 - OEM procedures and data
- Improve communication between acquisition and service facility
 - Quote system allows for detailed estimates to be shared

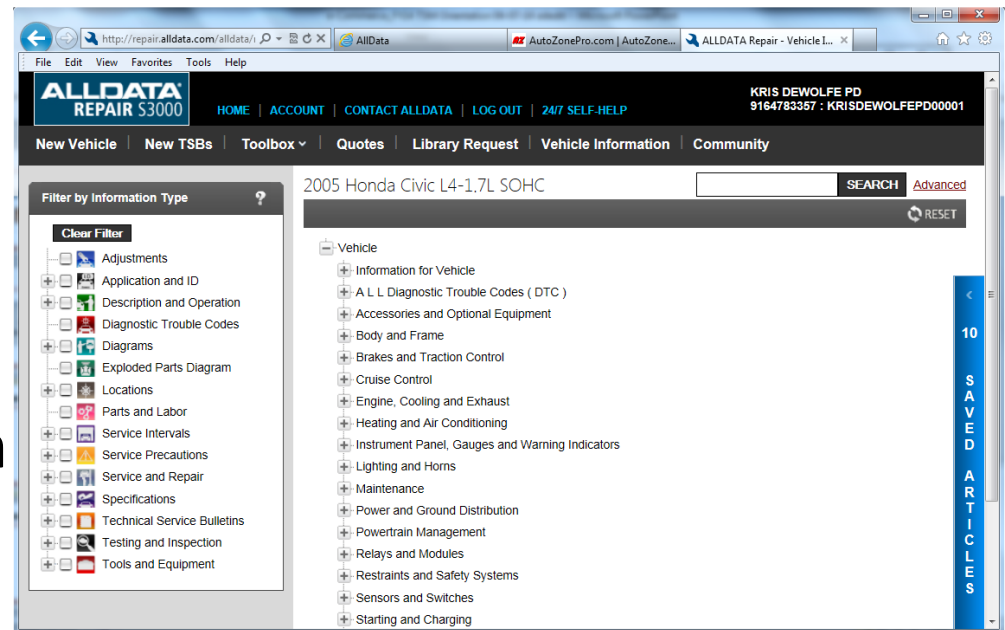

Improve Collision Operations

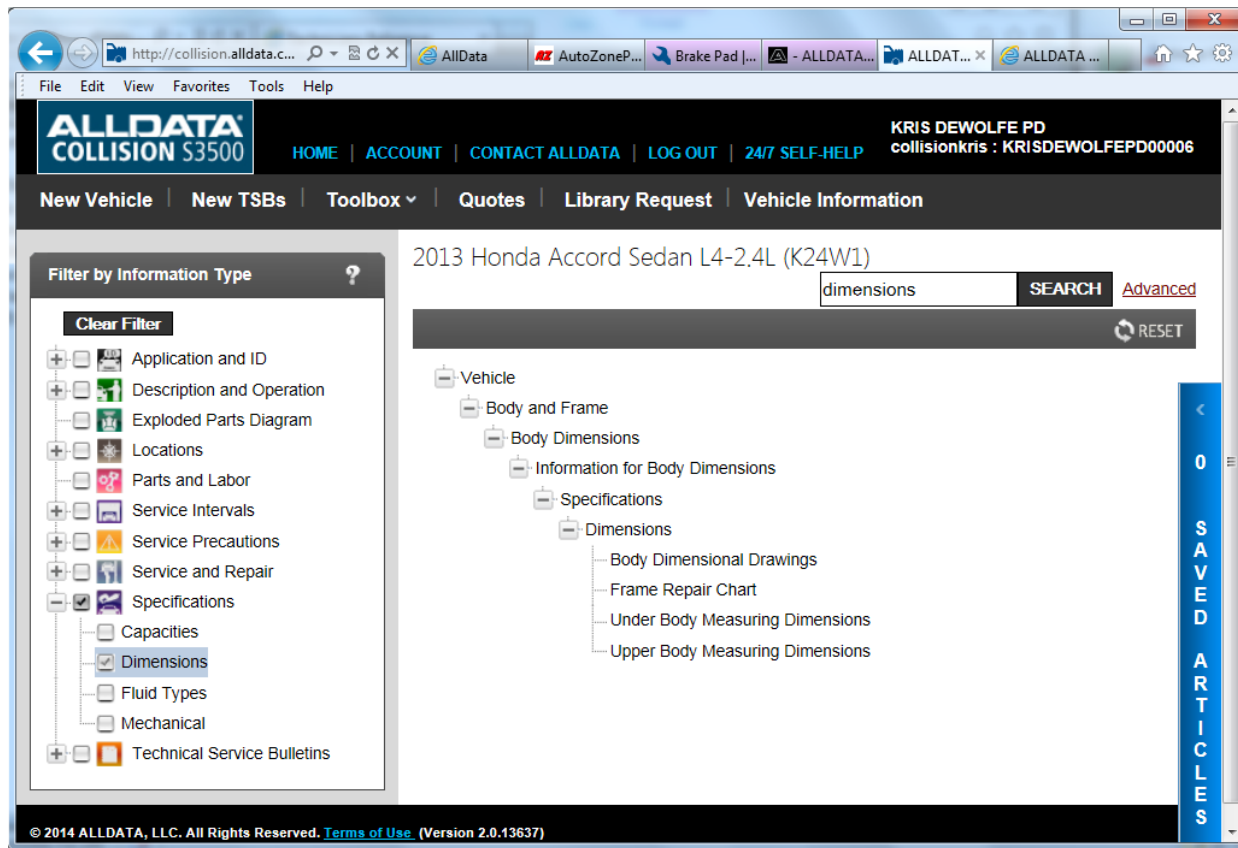

© 2014 ALLDATA, LLC. All Rights Reserved. [Terms of Use](#). (Version 2.0.13637)

Improve Collision Operations

ALLDATA Collision:

- Recondition Used Cars
 - Control Cost
 - Better Estimates
 - Step by Step Information
- Service All Vehicles
 - OEM information for “ALL Makes”
- Liability Pass through

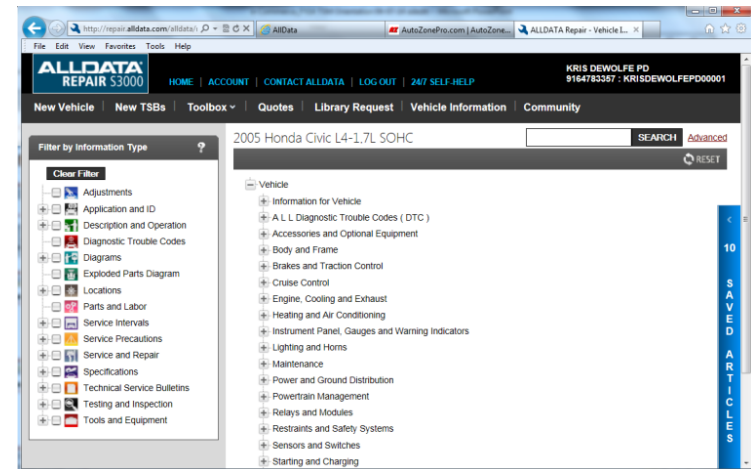

Thank you!